

HUB NUMBER OF GENERALIZED MIDDLE GRAPHS

B. BASAVANAGOUD¹, MAHAMMADSADIQ SAYYED¹, ANAND P. BARANGI¹, §

ABSTRACT. A *hub set* in a graph G is a set $S \subseteq V(G)$ such that any two vertices outside S are connected by a path whose all internal vertices are members of S . The minimum cardinality of hub set is called *hub number*. In this paper, we give results for the hub number of generalized middle graphs.

Keywords: hub set, hub number, middle graph..

AMS Subject Classification: 05C40, 05C69

1. INTRODUCTION

In 2006, Walsh came across the following problem: Imagine that we have a graph G which represents in a large industrial complex, with edge between two buildings if it is an easy walk from one to other. The corporation is considering implementation of a rapid-transit system (RTS) and wants to place its stations in buildings so that to travel between two nonadjacent buildings, one need only to walk to an adjacent station, take the RTS, and walk to the desired buildings. The corporation would like to implement this plan as cheaply as possible, which involves converting as few buildings as possible into transit stations.

Walsh [16], defined hub number of a graph to answer the above problem as follows: Let $G = (V, E)$ be a graph with $S \subseteq V(G)$ and let $x, y \in V(G)$. An S -path between x and y is a path where all intermediate vertices are from S . A set $S \subseteq V(G)$ is a *hub set* of G if it has the property that, for any $x, y \in V(G) \setminus S$ there is an S -path in G between x and y . The minimum cardinality of hub set is called *hub number* and is denoted by $h(G)$. The problem in the previous paragraph can be rephrased as: *what is the smallest size of a hub set in G ?* Later, Grauman et al. [6] obtained the relationship between hub

¹ Department of Mathematics, Karnatak University, Dharwad - 580 003, Karnataka, India.

e-mail: b.basavanagoud@gmail.com; ORCID: <https://orcid.org/0000-0002-6338-7770>.

e-mail: sadiqs26@gmail.com; ORCID: <https://orcid.org/0000-0003-1072-6879>.

e-mail: apb4maths@gmail.com; ORCID: <https://orcid.org/0000-0002-7100-8355>.

§ Manuscript received: February 20, 2020; accepted: October 08, 2020.

TWMS Journal of Applied and Engineering Mathematics, Vol.12, No.1 © Işık University,

Department of Mathematics, 2022; all rights reserved.

The first author has partially been supported by University Grant Commission (UGC), New Delhi, India through UGC-SAP DRS-III, 2016-2021: F.510/3/DRS-III/2016(SAP-I).

The second author has been supported by Directorate of Minorities, Government of Karnataka, Bangalore, through M.Phil/Ph.D fellowship-2019-20.

No.DOM/Ph.D/M.Phil/FELLOWSHIP/CR-01/2019-20 dated October, 15, 2019.

number, connected hub number and connected domination number of a graph. Chlebík et al. [4] studied approximation hardness of dominating set problems. Cauresma et al. [5] obtained hub number of join, corona and cartesian product of two connected graphs. Hamburger et al. [8] obtained size of a minimum routing set in subgraphs of the integer lattice. Basavanagoud et al. [2] obtained hub number of some wheel related graphs. Veena Mathad et al. [14] studied total hub number of graphs. Shadi Ibrahim Khalaf et al. [10, 11, 12] studied different forms of hub number like edge hub number, restrained hub number and hub and global hub numbers of graphs. Liu et al. [13] studied the hub number of co-comparability graphs. Now, in this paper, we obtain hub number of generalized middle graphs.

2. PRELIMINARIES

All graphs considered in this paper are nontrivial, connected, simple and undirected graphs. Let G be a graph with vertex set $V(G) = \{v_1, v_2, \dots, v_n\}$ and edge set $E(G) = \{e_1, e_2, \dots, e_m\}$. Thus $|V(G)| = n$ and $|E(G)| = m$ where, n and m are called *order* and *size* of G respectively. The *complement* of G [7] is denoted by \overline{G} whose vertex set is $V(G)$ and two vertices of \overline{G} are adjacent if and only if they are not adjacent in G . The *line graph* $L(G)$ of G [15] is a graph with vertex set as the edge set of G and two vertices of $L(G)$ are adjacent whenever the corresponding edges in G have a vertex in common. The *subdivision graph* $S(G)$ of G [7] is a graph whose vertex set is $V(G) \cup E(G)$ where two vertices are adjacent if and only if one is a vertex of \overline{G} and other is an edge of G incident with it. The *partial complement of subdivision graph* $\overline{S}(G)$ of G [9] is a graph whose vertex set is $V(G) \cup E(G)$ where two vertices are adjacent if and only if one is a vertex of G and the other is an edge of G not incident with it. For undefined terminology and notations refer [7].

The *generalized middle graph* G^{xy} , introduced recently by Basavanagoud et al. [3], is a graph having $V(G) \cup E(G)$ as the vertex set and $\alpha, \beta \in V(G) \cup E(G)$, α and β are adjacent in G^{xy} if and only if one of the following holds:

- (i) $\alpha, \beta \in E(G)$, α, β are adjacent in G if $x = +$ and α, β are not adjacent in G if $x = -$.
- (ii) $\alpha \in V(G)$ and $\beta \in E(G)$, α, β are incident in G if $y = +$ and α, β are not incident in G if $y = -$.

One can obtain the four graphical generalized middle graph transformations of graphs as G^{++} , G^{+-} , G^{-+} and G^{--} . An example of generalized middle graph transformations and their complements are depicted in Figure 1. Note that, G^{++} is just the middle graph of G , which was introduced by Akiyama et al. in [1]. The vertex v of G^{xy} corresponding to a vertex v of G is referred to as a *point vertex*. The vertex e of G^{xy} corresponding to an edge e of G is referred to as a *line vertex*. The vertex v of G^{xy} corresponding to a vertex v of G is referred to as a *incident point vertex* if vertex v is incident to edge $e = (u, v)$ in G . The vertex e of G^{xy} corresponding to an edge e of G is referred to as a *incident line vertex* if edge $e = (u, v)$ is incident to vertices u and v in G .

3. HUB NUMBER OF GENERALIZED MIDDLE GRAPHS

Theorem 3.1. *Let G be any graph of order n . Then*

$$h(G^{++}) = n - 1.$$

Proof. Let v_1, v_2, \dots, v_n be point vertices of G^{++} and e_1, e_2, \dots, e_m be line vertices of G^{++} . Consider $e_i \in V(G^{++})$ with maximum degree then $d_{G^{++}}(e_i) = d_G(u) + d_G(v)$. Now choose $S = \{e_1 | e_1 \in V(G^{++})\}$ such that e_1 has maximum degree in G^{++} i.e., $d_{G^{++}}(e_1)$ is atmost $\{d_G(u) + d_G(v)\}$ then each e_i is adjacent to *atmost* $\{d_G(u) + d_G(v)\}$ vertices.

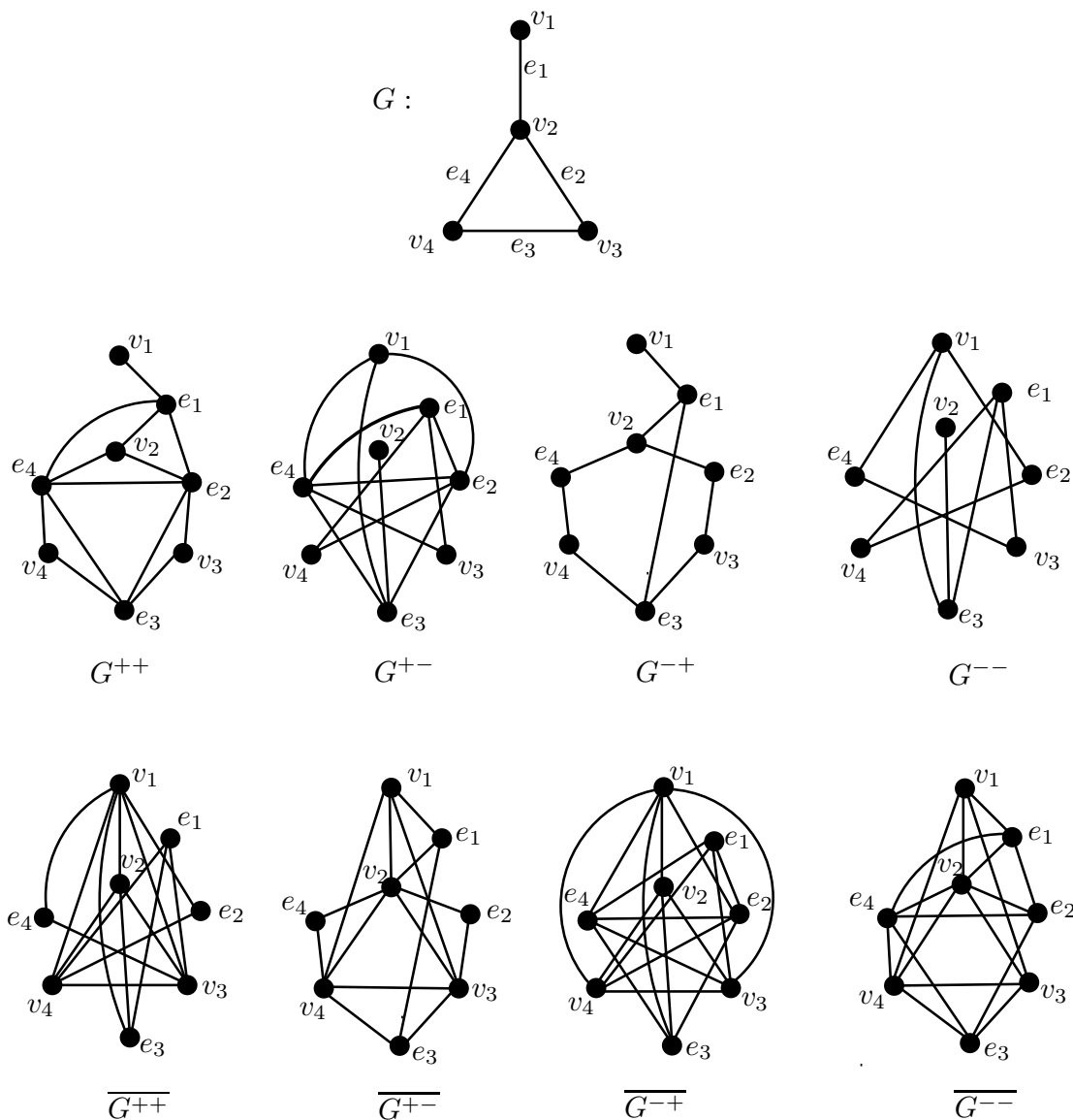

FIGURE 1. Graph G , its generalized middle graph transformations G^{xy} and their complements $\overline{G^{xy}}$.

Next, choose $e_2 \in V(G^{++})$ which has maximum degree and is adjacent to e_1 . Since each $e_i \in V(G^{++})$ is incident with $uv \in E(G)$ and has maximum degree in $V(G^{++})$, choosing $S = \{e_i | e_i \in V(G^{++}), 1 \leq i \leq n - 1\}$ gives the minimum hub set. Thus, $|S| = n - 1$. Hence, $h(G^{++}) = n - 1$. \square

Theorem 3.2. *Let G be any graph of order $n \geq 4$ and size $m \geq 2$. Then*

$$h(G^{+-}) = 3.$$

Proof. Let v_1, v_2, \dots, v_n be point vertices of G^{+-} and $e_1, e_2, \dots, e_m, m \geq 2$ be line vertices of G^{+-} . Choose any two line vertices having maximum degree in $V(G^{+-})$. Since any line vertex is adjacent to $(n - 2)$ point vertices. Choose point vertex v_i which is incident

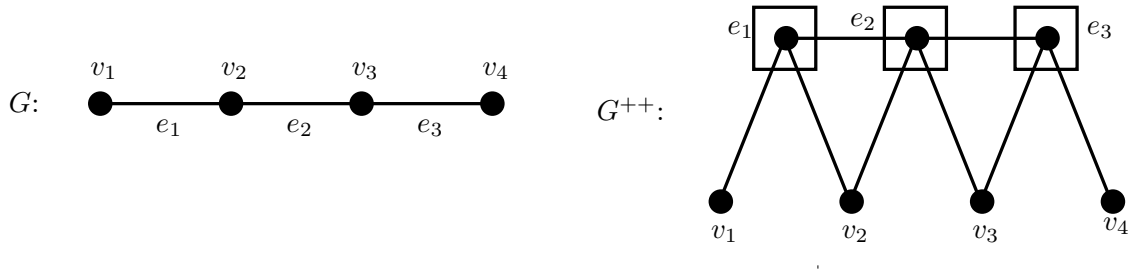

FIGURE 2. Choosing minimum hub set in graph G^{++} .

with line vertices e_1 and e_2 . Therefore, let $e_1 = v_1v_2$ and $e_2 = v_2v_3$ be two adjacent line vertices in $V(G^{+-})$. Then choosing $S = \{e_1, e_2, v_2\}$ gives the minimum hub set. Therefore, $|S| = 3$. Hence, $h(G^{+-}) = 3$. \square

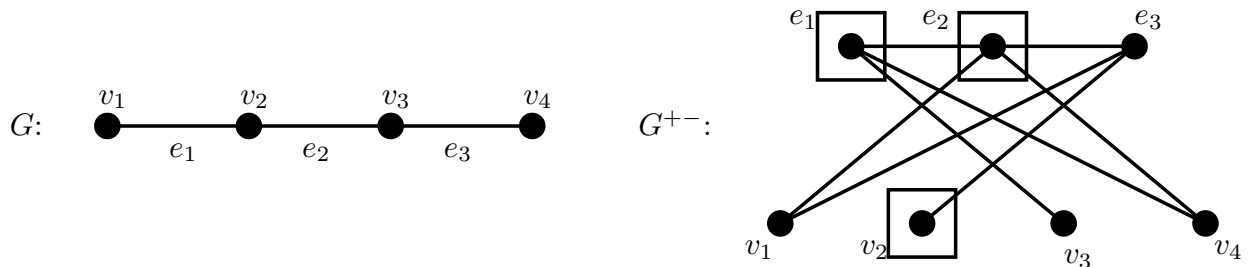

FIGURE 3. Choosing minimum hub set in graph G^{+-} .

Theorem 3.3. *Let G be any graph of order $n \geq 5$, not a star or complete graph. Then*

$$h(G^{-+}) = \lceil \frac{n}{2} \rceil.$$

Proof. Let v_1, v_2, \dots, v_n be point vertices of G^{-+} and e_1, e_2, \dots, e_m be line vertices of G^{-+} . Consider point vertex $v_i \in V(G^{-+})$, it is adjacent to incident line vertices. Each line vertex $e_i \in V(G^{-+})$ is adjacent to incident point vertices and nonincident line vertices. Now choose $S = \{e_i | e_i \in V(G^{-+})\}$ such that e_i has the maximum degree in G^{-+} . Choose a line vertex e_1 which has the maximum degree and adjacent to incident point vertices v_1 and v_2 . Next, choose $e_3 \in V(G^{-+})$ which is nonadjacent to point vertices v_1, v_2 but adjacent to a line vertex e_1 . Since $e_i \in V(G^{-+})$ with maximum degree then each $d_{G^{-+}}(e_i) = (m - d_G(u) + d_G(v)) + 3$. Choosing $S = \{e_1, e_2, \dots, e_{\lceil \frac{n}{2} \rceil}\}$ gives the minimum hub set. Thus, $|S| = \lceil \frac{n}{2} \rceil$. Hence, $h(G^{-+}) = \lceil \frac{n}{2} \rceil$. \square

Theorem 3.4. *Let G be any star or complete graph of order $n \geq 5$. Then*

$$h(G^{-+}) = n.$$

Proof. Let v_1, v_2, \dots, v_n be point vertices of G^{-+} and e_1, e_2, \dots, e_m be line vertices of G^{-+} . Consider point vertex $v_i \in V(G^{-+})$, it is adjacent to incident line vertices. Each line vertex $e_i \in V(G^{-+})$ is adjacent to incident point vertices and nonincident line vertices. Now choose $S = \{e_i | e_i \in V(G^{-+})\}$ such that e_i has the maximum degree in G^{-+} . Let G be a complete graph, choose n line vertices e_i which has maximum degree in G^{-+} which

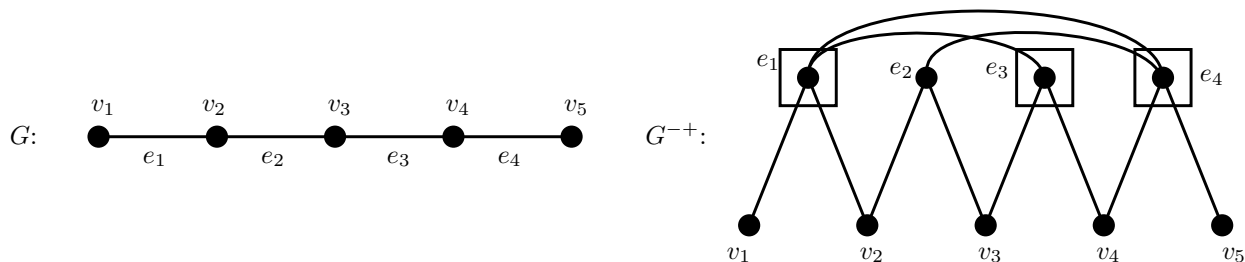

FIGURE 4. Choosing minimum hub set in graph G^{++} , when G is not a star or complete graph.

forms required S -path. Choosing $S = \{e_1, e_2, \dots, e_n\}$ gives the minimum hub set. Thus, $|S| = n$. Hence, $h(G^{++}) = n$. Let G be a star, choose point vertex v_i which has maximum degree in G and choose line vertices e_i which has incident point vertex v_i in G . Choosing $S = \{v_i, e_1, e_2, \dots, e_m\}$ gives the minimum hub set. Thus, $|S| = m + 1 = n$. Hence, $h(G^{++}) = n$. \square

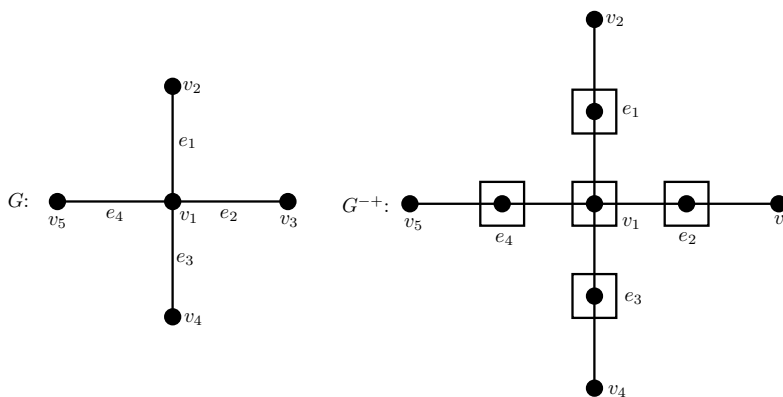

FIGURE 5. Choosing minimum hub set in graph G^{++} , when G is a star or complete graph.

Theorem 3.5. Let G be path of order $n \geq 5$. Then

$$h(G^{--}) = 2.$$

Proof. Let v_1, v_2, \dots, v_n be point vertices of G^{--} and e_1, e_2, \dots, e_m be line vertices of G^{--} . Choose two line vertices having maximum degree in G^{--} . Since any line vertex is adjacent to $(n-2)$ point vertices, choose two line vertices e_1 and e_2 which are incident with pendant vertices v_i and v_j in G . Then choosing $S = \{e_1, e_2\}$ gives the minimum hub set. Thus, $|S| = 2$. Hence, $h(G^{--}) = 2$. \square

Theorem 3.6. Let G be any graph of order $n \geq 5$, not a path. Then

$$h(G^{--}) = 3.$$

Proof. Let v_1, v_2, \dots, v_n be point vertices of G^{--} and e_1, e_2, \dots, e_m be line vertices of G^{--} . Choose any two line vertices having maximum degree in $V(G^{--})$. Since any line vertex is adjacent to $(n-2)$ point vertices, now choose $S = \{e_1 | e_1 \in V(G^{--})\}$ such that e_1 has maximum degree in G^{--} . Then each $e_i = uv$ is adjacent to $\{d_G(u) + d_G(v) - 1\}$

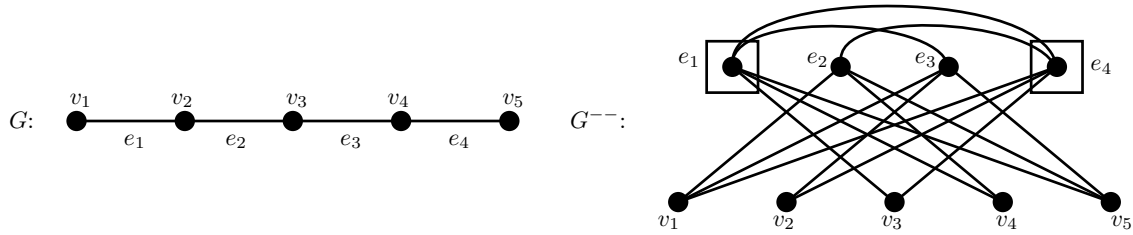

FIGURE 6. Choosing minimum hub set in graph G^{--} , when G is a path.

vertices. Next, choose $e_2 \in V(G^{--})$ which is adjacent to one common vertex e_1 . Choose $e_3 \in V(G^{--})$ which is adjacent to one common vertex e_2 . Then, choosing $S = \{e_1, e_2, e_3\}$ gives the minimum hub set. Thus, $|S| = 3$. Hence, $h(G^{--}) = 3$. \square

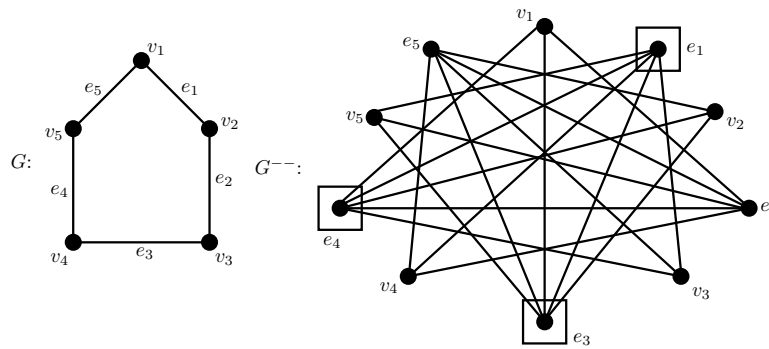

FIGURE 7. Choosing minimum hub set in graph G^{--} , when G is not a path.

Theorem 3.7. *Let G be any path or star or cycle of order $n \geq 4$. Then*

$$h(\overline{G^{++}}) = 2.$$

Proof. Let v_1, v_2, \dots, v_n be point vertices of $\overline{G^{++}}$ and e_1, e_2, \dots, e_m be line vertices of $\overline{G^{++}}$. Consider a point vertex v_i which is adjacent to nonincident line vertices in $V(\overline{G^{++}})$ and adjacent to all other point vertices in $\overline{G^{++}}$. Let G be a path or star, choose a point vertex v_i corresponding to a pendent vertex of G and line vertex e_i which is incident with v_i in G . Then $S = \{v_i, e_i\}$ which gives the minimum hub set. Thus, $|S| = 2$. Hence, $h(\overline{G^{++}}) = 2$. Let G be a cycle, choose a point vertex v_i which is adjacent to $2n - 3$ vertices in $\overline{G^{++}}$. Next choose another point vertex v_j which is adjacent to nonadjacent vertices with v_i in $\overline{G^{++}}$. $S = \{v_i, v_j\}$ which gives the minimum hub set. Thus, $|S| = 2$. Hence, $h(\overline{G^{++}}) = 2$. \square

Theorem 3.8. *Let G be any graph of order $n \geq 4$, not a path or star or cycle. Then*

$$h(\overline{G^{++}}) = 3.$$

Proof. Let v_1, v_2, \dots, v_n be point vertices of $\overline{G^{++}}$ and e_1, e_2, \dots, e_m be line vertices of $\overline{G^{++}}$. Let $v_i \in V(\overline{G^{++}})$ then each v_i is adjacent to $(n - 1)$ point vertices and $(m - d_G(v_i))$ line vertices in $\overline{G^{++}}$. Choose two adjacent point vertices v_1 and v_2 in $\overline{G^{++}}$. Next, choose a line vertex $e_i \in V(\overline{G^{++}})$ which is adjacent to point vertices v_1 and v_2 in $\overline{G^{++}}$. Then $S = \{v_1, v_2, e_1\}$ which gives the minimum hub set. Thus, $|S| = 3$. Hence, $h(\overline{G^{++}}) = 3$. \square

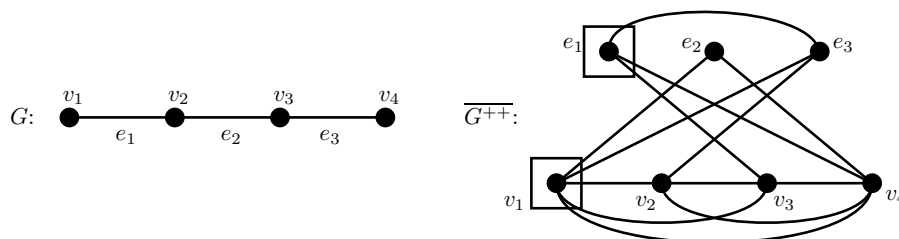

FIGURE 8. Choosing minimum hub set in graph $\overline{G^{++}}$, when G is a path.

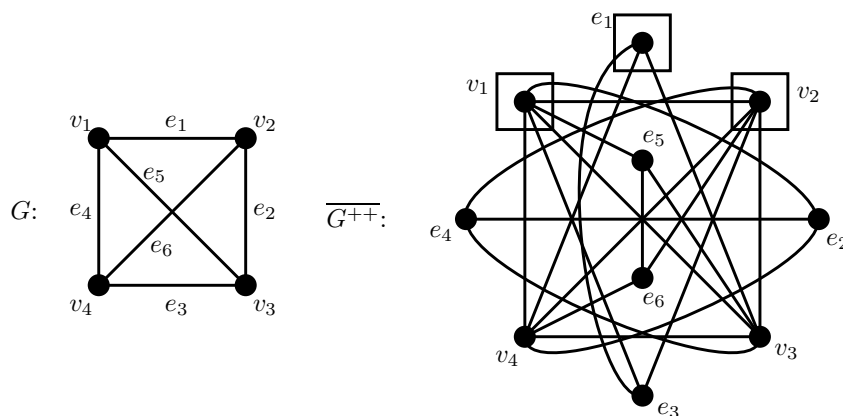

FIGURE 9. Choosing minimum hub set in graph $\overline{G^{++}}$, when G is not a path or star or cycle.

Theorem 3.9. *Let G be any star graph of order $n \geq 4$. Then*

$$h(\overline{G^{+-}}) = 1.$$

Proof. Let v_1, v_2, \dots, v_n be point vertices of $\overline{G^{+-}}$ and e_1, e_2, \dots, e_m be line vertices of $\overline{G^{+-}}$. Since the point vertex v_i in $\overline{G^{+-}}$ has the maximum degree, each point vertex v_i is adjacent to $(n - 1)$ point vertices and incident line vertices in $\overline{G^{+-}}$. Choose nonpendent vertex v_i in G , is sufficient to form S -path in $\overline{G^{+-}}$. Then $S = \{v_i\}$ gives the minimum hub set. Thus, $|S| = 1$. Hence, $h(\overline{G^{+-}}) = 1$. \square

Theorem 3.10. *Let G be any graph of order $n \geq 5$, not a star graph. Then*

$$h(\overline{G^{+-}}) = 3.$$

Proof. Let v_1, v_2, \dots, v_n be point vertices of $\overline{G^{+-}}$ and e_1, e_2, \dots, e_m be line vertices of $\overline{G^{+-}}$. Since the point vertex v_i in $\overline{G^{+-}}$ has the maximum degree, each point vertex v_i is adjacent to $(n - 1)$ point vertices and incident line vertices in $\overline{G^{+-}}$. Choose any two adjacent point vertices v_1, v_2 and line vertex e_i which is adjacent to point vertices v_1, v_2 in $V(\overline{G^{+-}})$. Then $S = \{v_1, v_2, e_1\}$ gives the minimum hub set. Thus, $|S| = 3$. Hence, $h(\overline{G^{+-}}) = 3$. \square

Theorem 3.11. *Let G be complete graph of order $n \geq 4$. Then*

$$h(\overline{G^{-+}}) = 3.$$

Proof. Let v_1, v_2, \dots, v_n be point-vertices of $\overline{G^{-+}}$ and e_1, e_2, \dots, e_m be line vertices of $\overline{G^{-+}}$. Since the point vertex $v_i \in V(\overline{G^{-+}})$ has the maximum degree, each point vertex v_i is

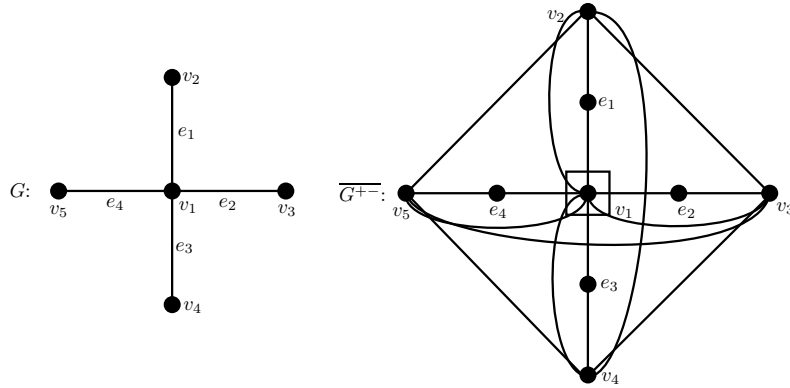

FIGURE 10. Choosing minimum hub set in graph $\overline{G^{+-}}$, when G is a star.

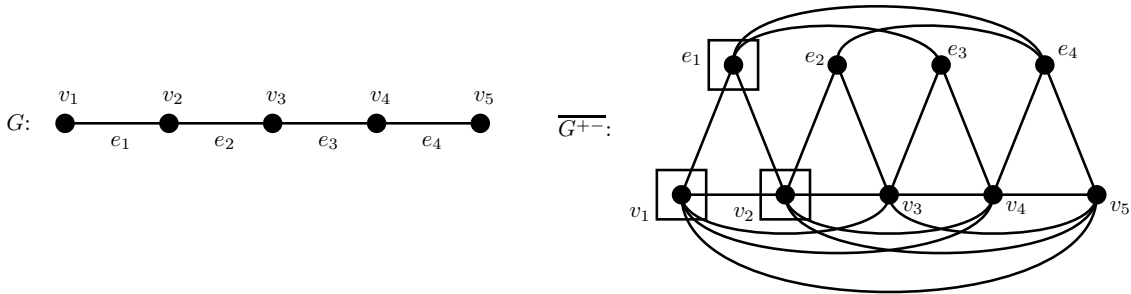

FIGURE 11. Choosing minimum hub set in graph $\overline{G^{+-}}$, when G is not a star.

adjacent to $(n - 1)$ point vertices and nonincident line vertices in $\overline{G^{+-}}$. Choose any two adjacent point vertices $v_i, v_j \in V(\overline{G^{+-}})$ which has the maximum degree in $V(\overline{G^{+-}})$. Next choose a line vertex e_i which is incident to one of point vertex v_i or v_j in G . Then $S = \{v_i, v_j, e_i\}$ gives the minimum hub set. Thus, $|S| = 2$. Hence, $h(\overline{G^{+-}}) = 3$. \square

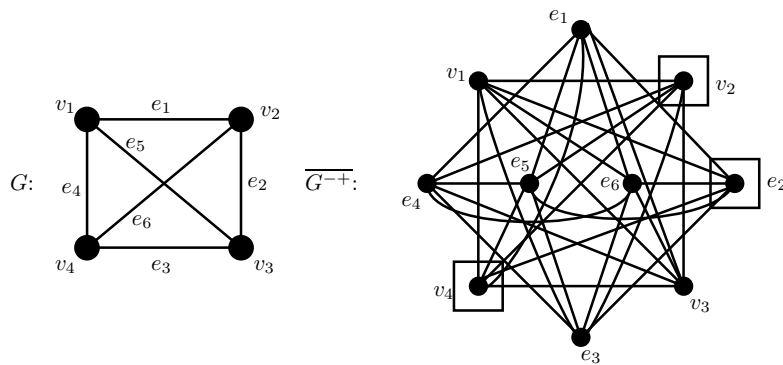

FIGURE 12. Choosing minimum hub set in graph $\overline{G^{+-}}$, when G is a complete graph.

Theorem 3.12. *Let G be any graph of order $n \geq 3$ and size $m > 2$, not a complete graph. Then*

$$h(\overline{G^{+-}}) = 2.$$

Proof. Let v_1, v_2, \dots, v_n be point-vertices of $\overline{G^{-+}}$ and e_1, e_2, \dots, e_m be line vertices of $\overline{G^{-+}}$. Since the point vertex $v_i \in V(\overline{G^{-+}})$ has the maximum degree, each point vertex v_i is adjacent to $(n - 1)$ point vertices and nonincident line vertices in $\overline{G^{-+}}$. Choose any two adjacent point vertices $v_i, v_j \in V(\overline{G^{-+}})$ which have the maximum degree in $V(\overline{G^{-+}})$. Then $S = \{v_1, v_2\}$ gives the minimum hub set. Thus, $|S| = 2$. Hence, $h(\overline{G^{-+}}) = 2$. \square

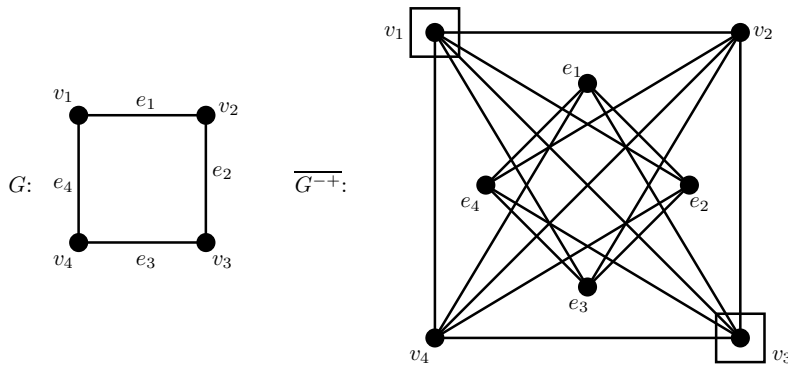

FIGURE 13. Choosing minimum hub set in graph $\overline{G^{-+}}$, when G is not a complete graph.

Theorem 3.13. *Let G be any path of order $n \geq 3$. Then*

$$h(\overline{G^{--}}) = \lfloor \frac{n}{2} \rfloor.$$

Proof. Let v_1, v_2, \dots, v_n be point vertices of $\overline{G^{--}}$ and e_1, e_2, \dots, e_m be line vertices of $\overline{G^{--}}$. Each point vertex v_i which is adjacent to $(n - 1)$ point vertices and incident line vertices in $\overline{G^{--}}$. Choose $v_1 \in V(\overline{G^{--}})$ which has maximum degree and adjacent to at least two incident line vertices e_1 and e_2 in $\overline{G^{--}}$. Next, choose $v_2 \in V(\overline{G^{--}})$ which is adjacent to v_1 and nonadjacent to e_1 and e_2 in $V(\overline{G^{--}})$. Similarly choose point vertices $v_i \in V(\overline{G^{--}})$ which forms a S -path between any two line vertices in $V(\overline{G^{--}})$. Choose set $S = \{v_1, v_2, v_3, \dots, v_{\lfloor \frac{n}{2} \rfloor}\}$ gives the minimum hub set. Thus, $|S| = \lfloor \frac{n}{2} \rfloor$. Hence, $h(\overline{G^{--}}) = \lfloor \frac{n}{2} \rfloor$. \square

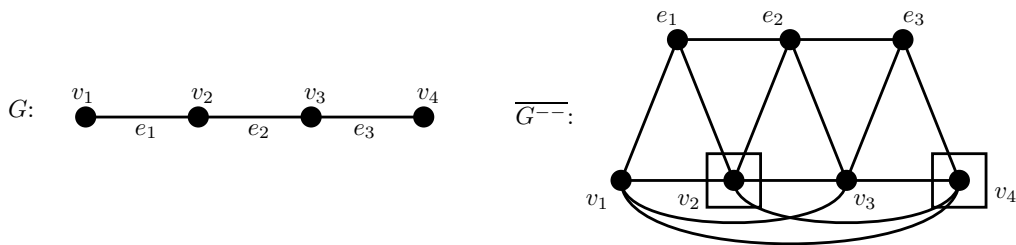

FIGURE 14. Choosing minimum hub set in graph $\overline{G^{--}}$, when G is a path.

Theorem 3.14. *Let G be cycle of order $n \geq 5$. Then*

$$h(\overline{G^{--}}) = \lfloor \frac{n}{2} \rfloor.$$

Proof. Let v_1, v_2, \dots, v_n be point vertices of $\overline{G^{--}}$ and e_1, e_2, \dots, e_n be line vertices of $\overline{G^{--}}$. Consider a point vertex $v_i \in V(\overline{G^{--}})$ is adjacent to $(n - 1)$ point vertices and incident line vertex in $\overline{G^{--}}$. Choose point vertex $v_1 \in V(\overline{G^{--}})$ which is adjacent to two incident line vertices e_1 and e_2 in $V(\overline{G^{--}})$. Next, choose $v_2 \in V(\overline{G^{--}})$ which is adjacent to v_1 and nonadjacent to line vertices e_1 and e_2 in $V(\overline{G^{--}})$. Choose point vertex $v_3 \in V(\overline{G^{--}})$ which is adjacent to vertices v_1 and $v_2 \in V(\overline{G^{--}})$. Similarly choose point vertices $v_i \in V(\overline{G^{--}})$ which forms a path between any vertices in $V(\overline{G^{--}})$. Choosing the set $S = \{v_1, v_2, v_3, \dots, v_{\lceil \frac{n}{2} \rceil}\}$ gives the minimum hub set. Thus, $|S| = \lceil \frac{n}{2} \rceil$. Hence, $h(\overline{G^{--}}) = \lceil \frac{n}{2} \rceil$. \square

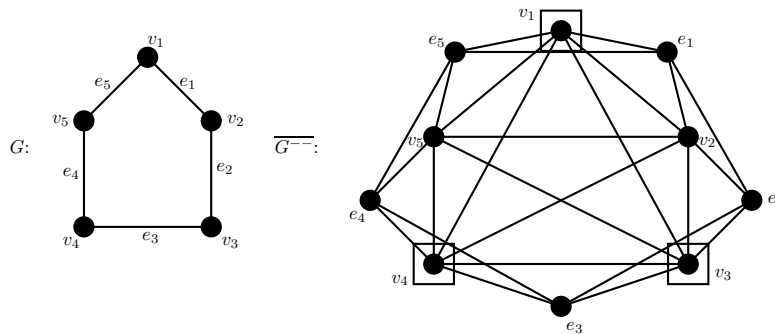

FIGURE 15. Choosing minimum hub set in graph $\overline{G^{--}}$, when G is a cycle.

Theorem 3.15. *Let G be star graph of order $n \geq 4$. Then*

$$h(\overline{G^{--}}) = 1.$$

Proof. Let v_1, v_2, \dots, v_n be point vertices of $\overline{G^{--}}$ and e_1, e_2, \dots, e_m be line vertices of $\overline{G^{--}}$. Each point vertex v_i which is adjacent to $(n - 1)$ point vertices and incident line vertices in $\overline{G^{--}}$. Choose a point vertex v_i which has maximum degree in G , is sufficient to form S -path in $\overline{G^{--}}$. Choosing set $S = \{v_i\}$ gives the minimum hub set. Thus, $|S| = 1$. Hence, $h(\overline{G^{--}}) = 1$. \square

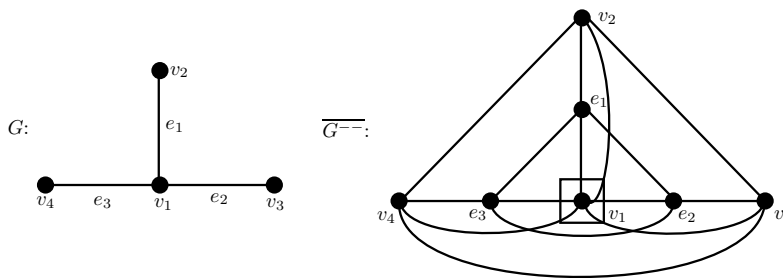

FIGURE 16. Choosing minimum hub set in graph $\overline{G^{--}}$, when G is a star.

Theorem 3.16. *Let G be any graph of order n and size $m \geq 5$, not a path or cycle or star. Then*

$$h(\overline{G^{--}}) = n - 1.$$

Proof. Let v_1, v_2, \dots, v_n be point vertices of $\overline{G^{--}}$ and $e_1, e_2, e_3, \dots, e_m$ be line vertices of $\overline{G^{--}}$. Since each point vertex v_i is adjacent to $(n - 1)$ point vertices and incident line vertices in $\overline{G^{--}}$, let $v_i \in V(\overline{G^{--}})$ then $d_{\overline{G^{--}}}(v_i) = \{n - 1 + d_G(v_i)\}$ for v_i has the maximum degree in $\overline{G^{--}}$. Now choose $S = \{v_i | v_i \in V(\overline{G^{--}})\}$ such that v_i , which is adjacent to incident line vertices e_i and have maximum degree in $V(\overline{G^{--}})$. Choosing $S = \{v_i | v_i \in V(\overline{G^{--}}), 1 \leq i \leq n - 1\}$ gives the minimum hub set. Thus, $|S| = n - 1$. Hence, $h(\overline{G^{--}}) = n - 1$. \square

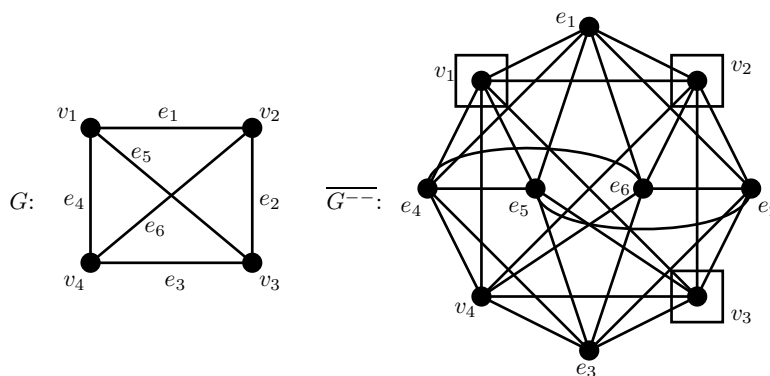

FIGURE 17. Choosing hub set in graph $\overline{G^{--}}$, when G is not a path or cycle or star.

4. CONCLUSIONS

The results presented in this paper are hub number of generalized middle graphs in terms of parameters of the graph considered. For further research we investigate different graph families obtained by various graph operations.

REFERENCES

- [1] Akiyama, J., Hamada, T. and Yoshimura, I., (1974), Miscellaneous properties of middle graphs, TRU Mathematics, 10, pp. 41-53.
- [2] Basavanagoud, B., Barangi, A. P. and Cangul, I. N., Hub number of some wheel related graphs, Adv. Stud. Contem. Math.,30 (3), pp. 325-334.
- [3] Basavanagoud, B., Gali, C. S. and Patil, S., (2016), On Zagreb indices and coindices of generalized middle graphs, Karnatak. Univ. J. Sci., 50, pp. 74-81.
- [4] Chlebík, M. and Chlebíkova, J., (2004), Approximation hardness of domonating set problems, In Algorithms-ESA 2004, Lecture Notes in Comput. Sci. 3221, (Springer, Berlin), pp. 192-203.
- [5] Cuaresma Jr, E. C. and Paluga, R. N., (2015), On the hub number of some graphs, Ann. stud. Sci. Humanities, 1 (1), pp. 17-24.
- [6] Grauman, T., Hartke, S. G., Jobson, A., Kinnersley, B., West, D. B., Wiglesworth, L., Worah, P. and Wu, H., (2008), The hub number of a graph, Inform. Process. Lett., 108 (4), pp. 226-228.
- [7] Harary, F., (1969), Graph Theory, Addison-Wesley, Reading.
- [8] Hamburger, P., Vandell, R. and Walsh, M., (2007), Routing sets in the integer lattice, Discrete Appl. Math., 155, pp. 1384-1394.
- [9] Indulal, G. and Vijayakumar, A., (2008), A note on energy of some graphs, MATCH Commun. Math. Comput. Chem., 59, pp. 269-274.
- [10] Khalaf, S. I., Mathad, V., (2019), Restrained hub number in graphs, Bull. Int. Math. Virtual Inst., 9, pp. 103-109.

- [11] Khalaf, S. I., Mathad, V., Mahde, S. S., (2019), Edge hub number in graphs, *Online J. Anal. Comb.*, 14:8.
- [12] Khalaf, S. I., Mathad, V., Mahde, S. S., (2020), Hub and global hub number of a graph, *Proc. Jangjeon Math. Soc.*, 2, pp. 231-239.
- [13] Liu, J. J., Wang, C. T. H., Wang, Y. L. and Yen, W. C. K., (2015), The hub number of co-comparability graphs, *Theoretical Comput. Sci.*, 570, pp. 15-21.
- [14] Mathad, V., Sahal, A. M., Kiran, S., (2014), The total hub number of graphs, *Bull. Int. Math. Virtual Inst.*, 4, pp. 61-67.
- [15] Whitney, H., (1932), Congruent graphs and the connectivity of graphs, *Amer. J. Math.*, 54 pp. 150-168.
- [16] Walsh, M., (2006), The hub number of a graph, *Int. J. Math. Comput. Sci.*, 1 (1), pp. 117-124.



B. Basavanagoud is a professor in the Department of Mathematics, Karnatak University, Dharwad, Karnataka, India. He was chairman of the department for two terms, 2010-2012 and 2016-2018. He has more than 30 years of teaching experience, completed several research projects and organized national/international conferences/workshops, guided M. Phil and Ph. D students. He has delivered several invited /contributed talks and has research publications in a reputed national/international journals. He was an Academic Council member of Karnatak University Dharwad (2017-2019). He is also life member for several academic bodies.



Anand P. Barangi received his M. Sc. degree from Karnatak University, Dharwad in 2015. Currently he is pursuing his Ph. D in Graph Theory under the supervision of Dr. B. Basavanagoud, Department of studies in Mathematics, Karnatak University, Dharwad, Karnataka, India. He has published more than ten research papers in international/national journals and presented research papers in conferences.



Mahamadsadiq Sayyed received his M.Sc. degree from Karnatak University, Dharwad in 2017. Currently he is pursuing his Ph. D in Graph Theory under the supervision of Dr. B. Basavanagoud, Department of studies in Mathematics, Karnatak University, Dharwad, Karnataka, India. He has presented research papers in international/national conferences. He received Directorate of Minorities fellowship, Bengaluru, Karnataka for three years.
